

TOPCU
VİNÇ & MAKİNA

“Yükünüzü Hafifletecek Teknolojiler”



CRANE SYSTEMS

2009 yılında Mersin’de faaliyete geçen firmamız müşterilerinden almış olduğu güç ve güven ile başta çukurova bölgesinde olmak üzere sektörün önde gelen firmaları arasında yerini alarak Türk sanayisine katma değeri yüksek üretimi ile katkı sunmaktadır.

Küçük bir atölyede başlayan üretim serüvenimiz bu gün 20 den fazla çalışanı ve 1500 m2 kapalı alana sahip fabrikamızda sürdürmekteyiz.

Bu gün Türkiyenin yaklaşık her bölgesinde çalışmakta olan vinçlerimizin gururunu yaşarken, çalışan bu vinçlerimizin sürdürülebilir teknik servis hizmet ağıımız ile maksimum verimlilik sağlayarak müşterilerimizin kullanımına sunmaktayız.

TOPCU VİNÇ olarak, Tek ve Çift Kirişli Portal Vinçler , Gezer Köprülü Çift Kiriş Tavan Vinçleri , Monoray Vinçler, Sabit tip vinçler , Pergel Vinçler , Arabalı Vinçler , Yandan Askılı ve Özel Vinç gruplarını üretmekteyiz. Üretmiş olduğumuz vinç sistemlerinin yanısıra yedek parçalarının da imalatını yapmaktayız. Vinçlerimizi profesyonel tasarım ve kaliteli işçilikle birleştirerek müşterilerimizin istekleri doğrultusunda en uygun çözümleri üretmekteyiz.

Our company, which started its operations in Mersin in 2009, takes its place among the leading companies of the sector, especially in the Çukurova region, with the strength and trust it has received from its customers, and contributes to the Turkish industry with its high added value production.

Our production adventure, which started in a small workshop, continues today in our factory with more than 20 employees and 1500 m2 closed area.

While we are proud of our cranes working in nearly every region of Turkey today, we offer these working cranes to our customers by providing maximum efficiency with our sustainable technical service network.

As TOPCU VİNÇ, we manufacture Single and Double Girder Gantry Cranes, Overhead Double Girder Overhead Cranes, Monorail Cranes, Fixed Type Cranes, Jib Cranes, Trolley Cranes, Side Suspended

2021 yılında 50 Adet Kaldırma Makinası Ürettik

We Produced 50 Lifting Machines in 2021

200 Ton Çelik imalatı gerçekleştirdik

We Performed 200 Tons of Steel Fabrication

Bugüne Kadar 400’ün üzerinde Vinç Sistemi Ürettik

We Have Produced Over 400 Crane Systems Until Today

1100’ün üzerinde Mutlu Müşteri

Over 1100 Happy Customers



+ 90 324 234 98 13



info@topcuvinc.com

KALİTE BELGELERİMİZ QUALITY CERTIFICATES



Marka Tescil Belgesi
Trademark Registration Certificate



TSE Hizmet Yeterlilik Belgesi
TSE Service Qualification Certificate



Yerli Mali Belgesi
Domestic Goods Certificate



ISO 9001:2015 Kalite Yönetim Sistemi
ISO 9001:2015 Quality Management System



CE Belgesi
CE Certificate



ÇİFT KİRİŞ ARABALI VİNÇ KEDİSİ

DOUBLE GIRDER HOIST TROLLEY

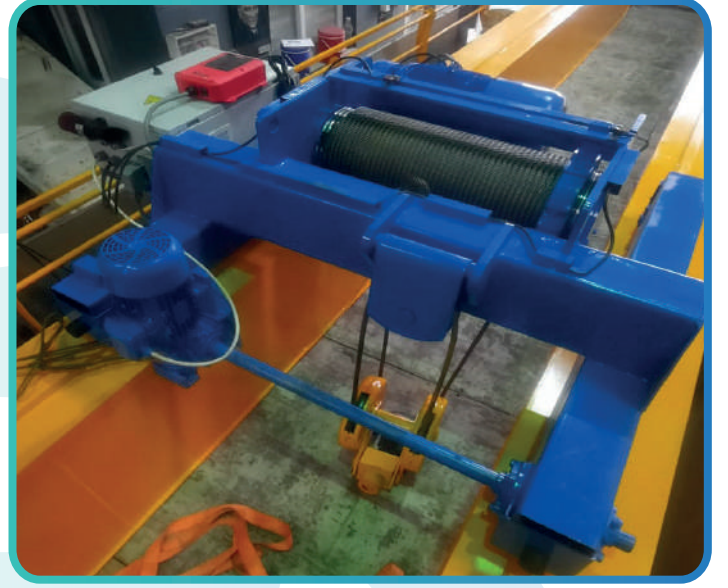
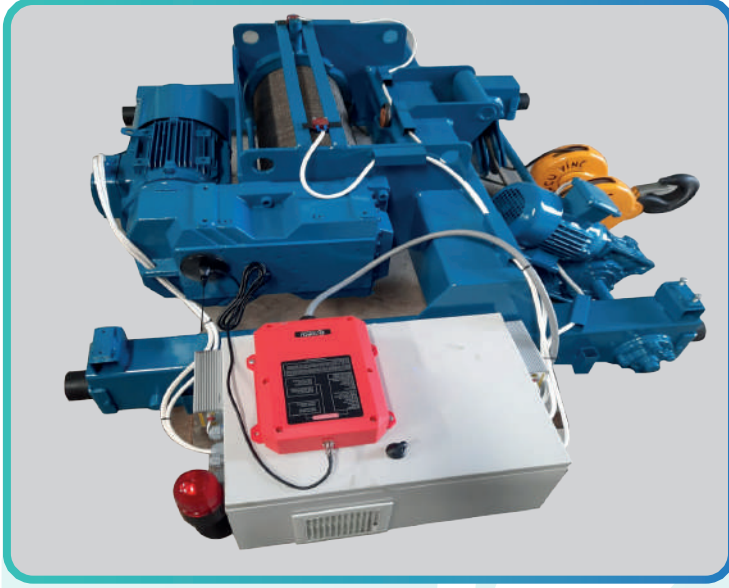

Teknik Özellikler / Technical Features

Kapasite Capacity	Tip Type	Kaldırma Hızı Hoist Speed	Kaldırma Yüksekliği Hoist height	Yürütme Hızı Lifting Speed	Halat Çapı Rope Reeving	Halat Donanımı Wire Rope
TON		mt/dk		mt/dk		
1	TPC/AV/1	2-8 / 1-5	1 - 100	5-25	8-6	1/2 - 1/4
2	TPC/AV/2	2-8 / 1-5	1 - 100	5-25	10-8	1/2 - 1/4
3	TPC/AV/3	2-8 / 1-5	1 - 100	5-25	10-8	1/2 - 1/4
5	TPC/AV/5	1-5	1 - 100	5-20	10	1/4
7,5	TPC/AV/7,5	1-5	1 - 100	5-20	12	1/4
10	TPC/AV/10	1-4 / 0,5 - 2,5	1 - 100	5-20	14	1/4
15	TPC/AV/15	1-4 / 0,5 - 2,5	1 - 100	5-17	18-14	1/4 - 1/6
20	TPC/AV/20	1-4 / 0,5 - 2,5	1 - 100	5-17	16-20	1/4 - 1/6
25	TPC/AV/25	1-4 / 0,5 - 2,5	1 - 100	5-17	16-20	2/8 - 1/6
30	TPC/AV/30	1-4 / 0,5 - 2,5	1 - 100	5-15	18-20	2/8 - 1/6
35	TPC/AV/35	1-4 / 0,5 - 2,5	1 - 100	5-15	20-22	2/8 - 1/6
40	TPC/AV/40	1-4 / 0,5 - 2,5	1 - 100	5-15	20-24	2/8 - 1/6
50	TPC/AV/50	1-4 / 0,5 - 2,5	1 - 100	5-15	22-26	2/8 - 1/6

MONORAY VİNÇ

MONORAIL HOIST

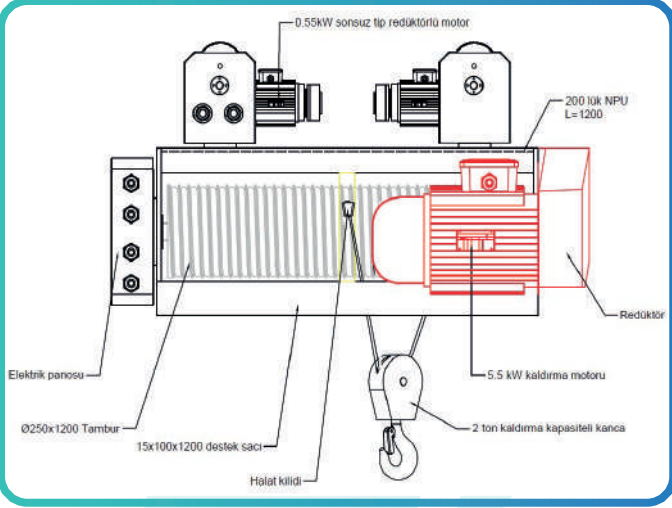
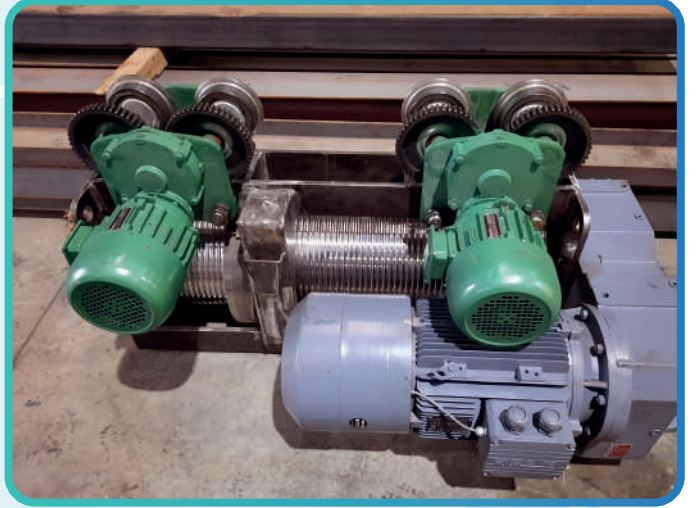

Teknik Özellikler / Technical Features

Kapasite Capacity	Tip Type	Kaldırma Hızı Hoist Speed	Kaldırma Yüksekliği Hoist height	Yürütme Hızı Lifting Speed	Halat Çapı Rope Reeving	Halat Donanımı Wire Rope
TON		mt/dk		mt/dk		
1	TPC/MV/1	2-8 / 1-5	1 - 100	5-25	8	1/2 - 1/4
2	TPC/MV/2	2-8 / 1-5	1 - 100	5-25	8	1/2 - 1/4
3	TPC/MV/3	2-8 / 1-5	1 - 100	5-25	8	1/2 - 1/4
5	TPC/MV/5	1-5	1 - 100	5-20	12	1/4
7,5	TPC/MV/7,5	1-5	1 - 100	5-20	12	1/4
10	TPC/MV/10	1-4 / 0,5 - 2,5	1 - 100	5-20	14	1/4

GEZER KÖPRÜLÜ VİNÇ / TEK KİRİŞ

OVERHEAD TRAVELLING CRANE / SINGLE GIRDER



Uzman Metal Mersin / 3 Ton

Standart Özellikler / Standart Features

Araba ve köprü yürüme duruşları için Limit switch

Limit switch for car and bridge walking stops

Araba ve köprü yürüme duruşları için tamponlar

End stoppers and buffers in cross travel & long travel

Bakım platformu

Maintenance platform

Sürücülü köprü yürütme

Inverter driven bridge travel

Sesli ve Işıklı ikaz lambası

Audible and Illuminated warning lamp

Faz Koruma Rolesi

Phase protection relay

Acil durdurma butonu

Emergency stop button

C Korniş Köprü elektrik besleme sistemi

C Cornice Bridge electrical supply system

Elektromanyetik Frenleme sistemi

Electromagnetic Braking system

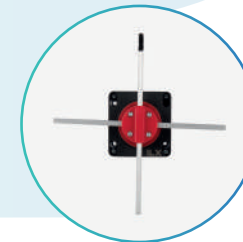

GEZER KÖPRÜLÜ VİNÇ / TEK KİRİŞ OVERHEAD TRAWELLING CRANE / SINGLE GIRDER



Opsiyonel Özellikler / Optional Features

Uzaktan Kumanda

Remote Control

Aşırı Yük Switch'ci

Over-load limiter

Kablo toplama tamburu

Cable reel (manual / motorized)

Araba yürüyüşü için frekans invertörü

Frequency inverter for walking car

Kanca için frekans invertörü

Frequency inverter for hook

Çarpışma önleyici sensör

Anti-collision sensor

Kapalı Busbar uygulaması

Indoor Busbar application

Dijital yük hücresi

Digital load cell

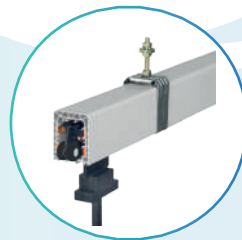
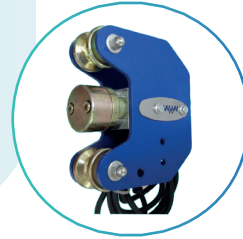

GEZER KÖPRÜLÜ VİNÇ / ÇİFT KİRİŞ OVERHEAD TRAVELLING CRANE / DOUBLE GIRDER



Ahmet Yüksel İnşaat Mersin / 10 Ton

Standart Özellikler / Standart Features

Araba ve köprü yürüme duruşları için Limit switch

Limit switch for car and bridge walking stops

Araba ve köprü yürüme duruşları için tamponlar

End stoppers and buffers in cross travel & long travel

Bakım platformu

Maintenance platform

Sürücülü köprü yürütme

Inverter driven bridge travel

Sesli ve Işıklı ikaz lambası

Audible and illuminated warning lamp

Faz Koruma Rolesi

Phase protection relay

Acil durdurma butonu

Emergency stop button

C Korniş Köprü elektrik besleme sistemi

C Cornice Bridge electrical supply system

Elektromanyetik Frenleme sistemi

Electromagnetic Braking system

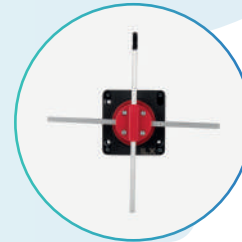

GEZER KÖPRÜLÜ VİNÇ / ÇİFT KİRİŞ OVERHEAD TRAVELLING CRANE / DOUBLE GIRDER



Çelikler Ticaret Silifke / 7,5 Ton

● Opsiyonel Özellikler / Optional Features

Uzaktan Kumanda

Remote Control

Aşırı Yük Switch'ci

Over-load limiter

Araba yürüyüşü için frekans invertörü

Frequency inverter for walking car

Kanca için frekans invertörü

Frequency inverter for hook

Çarpışma önleyici sensör

Anti-collision sensor

Kapalı Busbar uygulaması

Indoor Busbar application

Dijital yük hücresi

Digital load cell

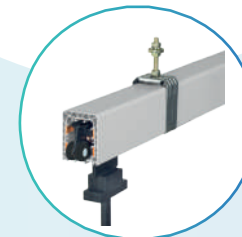

GEZER KÖPRÜLÜ VİNÇ / ÇİFT KİRİŞ OVERHEAD TRAVELLING CRANE / DOUBLE GIRDER



Güleç İnşaat Malz. Mut / 10 Ton



Çortullar İnşaat Mersin / 5 Ton



Sontek Makina Mersin / 10 Ton



Arılar Demir Niğde / 10 Ton



Pişirgen Makina Mersin / 5 Ton



Muammer Karoseri Ankara / 5 Ton

GEZER KÖPRÜLÜ VİNÇ / ÇİFT KİRİŞ OVERHEAD TRAVELLING CRANE / DOUBLE GIRDER



Çavuşoğlu Sera Anamur / 10 Ton



Uysallar Ticaret Bozyazı / 7,5 Ton



Uğurlar Makina Mersin / 15Ton



Cemre Sera Mersin / 10 Ton



Er Metal Mut / 10 Ton



Koyuncu Çelik Mersin / 10 Ton

GEZER KÖPRÜLÜ VİNÇ / ÇİFT KİRİŞ

OVERHEAD TRAVELLING CRANE / DOUBLE GIRDER



LTF Treyler Adana / 5 Ton 4 adet



Terra Rossa Mersin / 10 Ton



Akkuyu NGS / Gülnar 5 Ton



Düzgün Kardeşler Sera Mersin / 10 ton



Yüce Sera Group Mersin / 10 Ton



Ulusoy Lazer Mersin / 10 Ton

GEZER KÖPRÜLÜ VİNÇ / ÇİFT KİRİŞ OVERHEAD TRAVELLING CRANE / DOUBLE GIRDER



Ekinler Mermer Silifke / 10



Uyarlar İnşaat Mersin / 5 Ton



As Stor Yapı Sistemleri Aydın / 10 Ton



Tuğrakan Ferforje Mersin / 5 Ton



Toroslar Demir Erdemli / 5 Ton



Borşen Paslanmaz Boru Adana / 10 Ton 2 Adet

GEZER KÖPRÜLÜ VİNÇ / ÇİFT KİRİŞ OVERHEAD TRAVELLING CRANE / DOUBLE GIRDER



Parkvizyon Tokat / 3 Ton 3 Adet



Keskin Group Mersin / 10 Ton



Öz Altuntaş Metal Adana / 10 Ton 2 Adet



Öz Altuntaş Metal Adana / 10 Ton 2 Adet



İmza Global Mersin / 5 Ton 2 Adet



Alagöz Demir Mut / 10 Ton



Sempek Mermer Hatay / 10 Ton

Standart Özellikler / Standart Features

Araba ve köprü yürüme duruşları için Limit switch

Limit switch for car and bridge walking stops

Araba ve köprü yürüme duruşları için tamponlar

End stoppers and buffers in cross travel & long travel

Bakım platformu

Maintenance platform

Sürücülü köprü yürütme

Inverter driven bridge travel

Sesli ve ışıklı ikaz lambası

Audible and illuminated warning lamp

Faz Koruma Rolesi

Phase protection relay

Acil durdurma butonu

Emergency stop button

C Korniş Köprü elektrik besleme sistemi

C Cornice Bridge electrical supply system

Elektromanyetik Frenleme sistemi

Electromagnetic Braking system

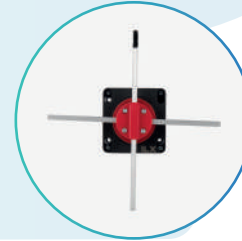

PORTAL VİNÇ SİSTEMLERİ

GANTRY CRANE SYSTEMS



Kılıçlar Granit Mermer Silifke / 10 Ton

Opsiyonel Özellikler / Optional Features

Uzaktan Kumanda

Remote Control

Aşırı Yük Switch'ci

Over-load limiter

Kablo toplama tamburu

Cable reel (manual / motorized)

Araba yürüyüşü için frekans invertörü

Frequency inverter for walking car

Kanca için frekans invertörü

Frequency inverter for hook

Çarpışma önleyici sensör

Anti-collision sensor

Kapalı Busbar uygulaması

Indoor Busbar application

Dijital yük hücresi

Digital load cell

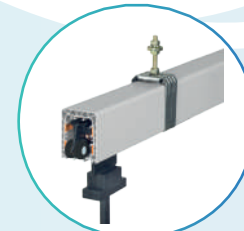

PORTAL VİNÇ SİSTEMLERİ GANTRY CRANE SYSTEMS



Ünaltun Granit Mersin / 40 Ton



Falcon Impex Granite Marble Mersin / 40 Ton



Ünaltun Granit Mersin / 20 Ton



Sg Mühendislik Bilecik / 3 Ton



Baran Mermer Silifke / 30 Ton



Doğrutaş Mermer Antalya / 15 Ton

PORTAL VİNÇ SİSTEMLERİ / GANTRY CRANE SYSTEMS KÖPRÜLÜ VİNÇ SİSTEMLERİ / OVERHEAD CRANE SYSTEMS

	TEK KİRİŞLİ VİNÇ SİSTEMLERİ (PORTAL-GEZER-MONORAY) SINGLE GIRDER CRANE SYSTEMS (GANTRY-OVERHEAD-MONORAIL)	ÇİFT KİRİŞLİ VİNÇ SİSTEMLERİ (PORTAL-GEZER-ARABALI) DOUBLE GIRDER CRANE SYSTEMS (GANTRY-OVERHEAD-TROLLEY)
KALDIRMA KAPASİTESİ (TON) LIFTING CAPACITY (TON)	110	1150
KÖPRÜ GENİŞLİK (M)/ BRIDGE WIDTH (M) *	040	040
KALDIRMA YÜKSEKLİĞİ (M) ** LIFTING HEIGHT (M)	6150	6150
KALDIRMA HIZI ** LIFTING SPEED	Tek m/dk Single m/min	202
	Çift m/dk Double m/min	0-200-2
KALDIRMA FRENİ LIFTING BRAKE	Elektromanyetik Electromagnetic	Elektromanyetik-Eldro-Hydro-Disk Electromagnetic-Eldro-Hydro-Disc
KALDIRMA REDÜKTÖR LIFTING GEARBOX	Endüstriyel, Paralel millî dişli kutusu Industrial, parallel shaft gearbox	Endüstriyel, Paralel millî dişli kutusu Industrial, parallel shaft gearbox
HAREKET = YÖN SAYISI MOTION = NUMBER OF DIRECTIONS	x-y-z-(sağ-sol,yukarı-aşağı,ileri-geri) x-y-z-(right-left, up-down, forward-backward)	x-y-z-(sağ-sol,yukarı-aşağı,ileri-geri) x-y-z-(right-left, up-down, forward-backward)
HALAT TİPİ - ÇAP (mm) *** ROPE TYPE - DIAMETER (mm)	6*36 F.C & IWRC 08-70 mm	6*36 F.C & IWRC 08-70 mm
HALAT KLAUZUZU /ROPE GUIDE	GGG50	GGG50
HALAT DONANIMI 1/x **** ROPE REEVING 1/x	1/1 -2/1- 4/1- 4/2 4/2-Z / 8/2-Z	1/1, 2/1-4/1, 6/1, 8/1, 4/2, 8/2, 12/2 4/2-Z / 8/2-Z / 12/2-Z
KANCA HOOK	15401 Tek - 15402 Çift Ağızlı P / S CLASS 15401 Single - 15402 Double Head P/S CLASS	15401 Tek - 15402 Çift Ağızlı P / S CLASS 15401 Single -15402 Double Head P/S CLASS
KANCA BLOK YAPISI HOOK BLOCK STRUCTURE	Standart/Kompakt/Özel tasarım Standard/Compact/ Special design	Standart/Kompakt/Özel tasarım Standard/Compact/ Special design
VİNÇ YÜRÜME HIZI ** CRANE WALKING SPEED	Tek m/dk Single m/min	520
	Çift m/dk Double m/min	0-50-20
VİNÇ YÜRÜME REDÜKTÖRÜ CRANE WALKING GEARBOX	Endüstriyel Monoblok Industrial Monoblock	Endüstriyel Monoblok, Paralel millî dişli kutusu Industrial Monoblock, parallel shaft gearbox
KÖPRÜ YÜRÜME HIZI ** BRIDGE WALKING SPEED	Tek m/dk Single m/min	540
	Çift m/dk Double m/min	0-50-40
KÖPRÜ FRENİ BRIDGE BRAKE	Elektromanyetik Electromagnetic	Elektromanyetik-Eldro-Hydro-Disk Electromagnetic-Eldro-Hydro-Disc
KÖPRÜ YÜRÜTME REDÜKTÖRÜ BRIDGE TRAVELLING GEARBOX	Endüstriyel Monoblok Industrial Monoblock	Endüstriyel Monoblok, Paralel millî dişli kutusu Industrial Monoblock, parallel shaft gearbox
KÖPRÜ VE HOL ENERJİ HATTI BRIDGE AND CORRIDOR ENERGY LINE	C Ray-NPI profil-Bara-Kablo toplama Tamburu C Rail-NPI profile-Busbar-Cable pulley	C Ray-NPI profil-Bara-Kablo toplama Tamburu C Rail-NPI profile-Busbar-Cable pulley
KUMANDA TİPİ CONTROL TYPE	Pendant kablolu Bush buton, Uzaktan Kumanda, Joystick Pendant Cabled Bush button, Remote Control, Joystick	Pendant kablolu Bush buton, Uzaktan Kumanda, Joystick Pendant Cabled Bush button, Remote Control, Joystick
KUMANDA GERİLİMİ (V) /CONTROL VOLTAGE (V)	24-48-220V AC	24-48-220V AC
ŞEBEKE GERİLİMİ (V) & FREKANS (Hz) MAINS VOLTAGE (V) & FREQUENCY (Hz)	380-400V 50 Hz 400-460V 60 Hz	380-400V 50 Hz 400-460V 60 Hz

* Daha yüksek açıklıklar için lütfen iletişime geçiniz.

* For higher openings please contact us.

** 125 m kaldırma yüksekliği, 0,5 m/s kaldırma hızı ve 2 m/s yürütme hızına kadar uygulamalarımız bulunmaktadır.

** We have applications up to 125 m lifting height, 0,5 m/s lifting speed and 2 m/s propulsion speed.

*** Proje yapısına göre, özel üretilmiş yüksek mukavemetli yeni nesil kompakt halatlar uygulamalarımızda bulunmaktadır.

*** According to the project structure, specially produced new generation compact ropes with high strength are available in our applications.

**** Proje yapısına göre donam tasarımı saklıdır.

**** Our hardware design is reserved according to the project structure.

TEK KİRİŞLİ PORTAL VİNÇLER SINGLE GIRDER GANTRY CRANES



PERGEL VİNÇ SİSTEMLERİ

JIB CRANE SYSTEMS



Sütun Destekli



Kolondan Destekli

Standart Özellikler / Standart Features

- 90° - 180° - 270° - 360° dönlü pergel seçenekleri
- 90° - 180° - 270° - 360° slewing options
- Soguk çekme dikişsiz çelik boru konstrüksiyon
- Cold seamless steel pipe structure
- C korniş elektrik sistemi
- C cornice electric system

Opsiyonel Özellikler / Optional Features

- Manuel veya motorlu vinç hareketi
- Manual or motorized hoist travel
- Manuel veya motorlu dönlüş hareketi
- Manual or motorized slewing
- Uzaktan Kumanda
- Remote Control

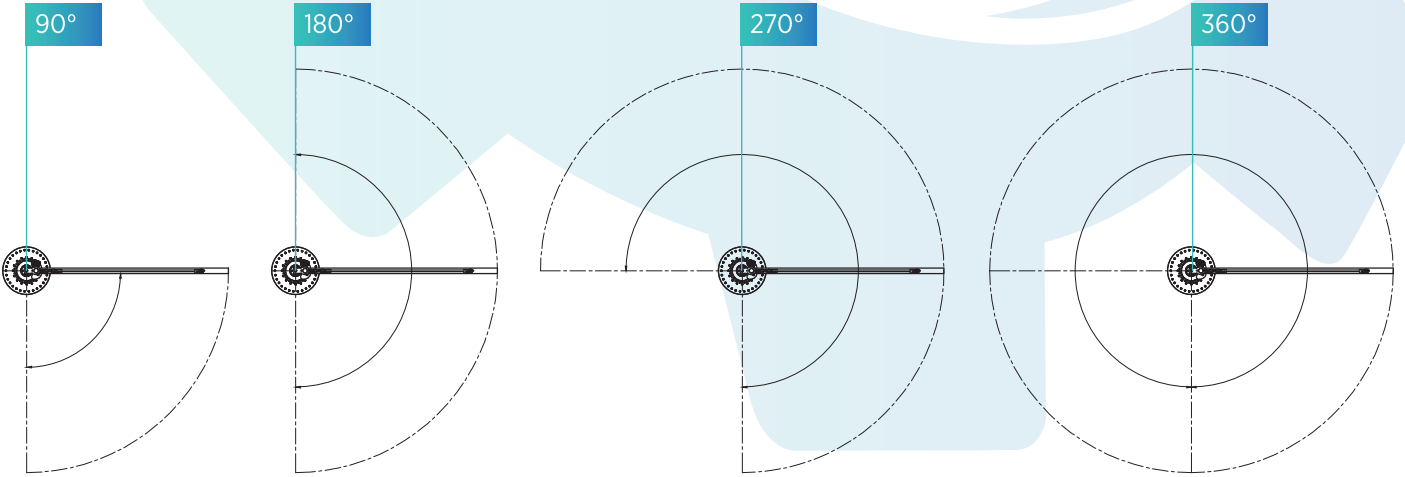

PERGEL VİNÇ SİSTEMLERİ JIB CRANE SYSTEMS



KANCA ALTI ATAÇMANLAR SIX HOOK ATTACHMENTS



Konteyner İçi Cam Yükleme Aparatı / Container Glass Loading Apparatus



Konteyner İçi Mermer Yükleme Aparatı (Sabit Tip) / In-Container Marble Loading Apparatus (Fixed Type)

KANCA ALTI ATAÇMANLAR SIX HOOK ATTACHMENTS



Konteyner İçi Mermer Yükleme Aparatı (Ayarlı Tip) / In-Container Marble Loading Apparatus (Adjustable Type)



KANCA ALTI ATAÇMANLAR SIX HOOK ATTACHMENTS



Rulo Sac Kaldırma Aparatı
Coil Lifting Apparatus



Çelik Sapan Halatlar
Steel Sling Ropes

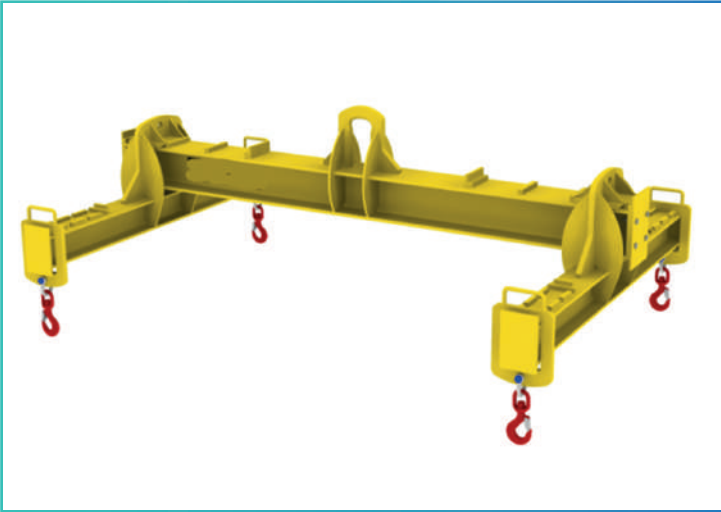

Konteyner Travers
Container Traverse



Çelik Sapan Halatlar
Steel Sling Ropes

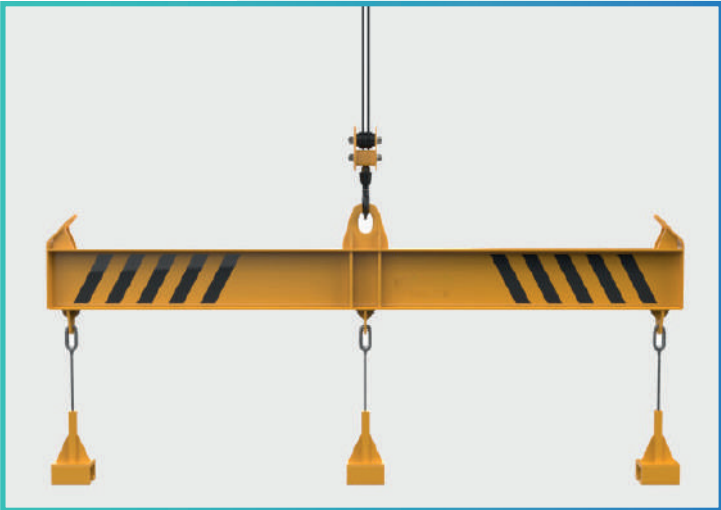

Vinç Denge Traversi
Crane Balance Crossmember



Taş Kapma Aparatı
Stone Grabber



YÜRÜYÜŞ BAŞLIK TAKIMI

WALKING HEADSETS

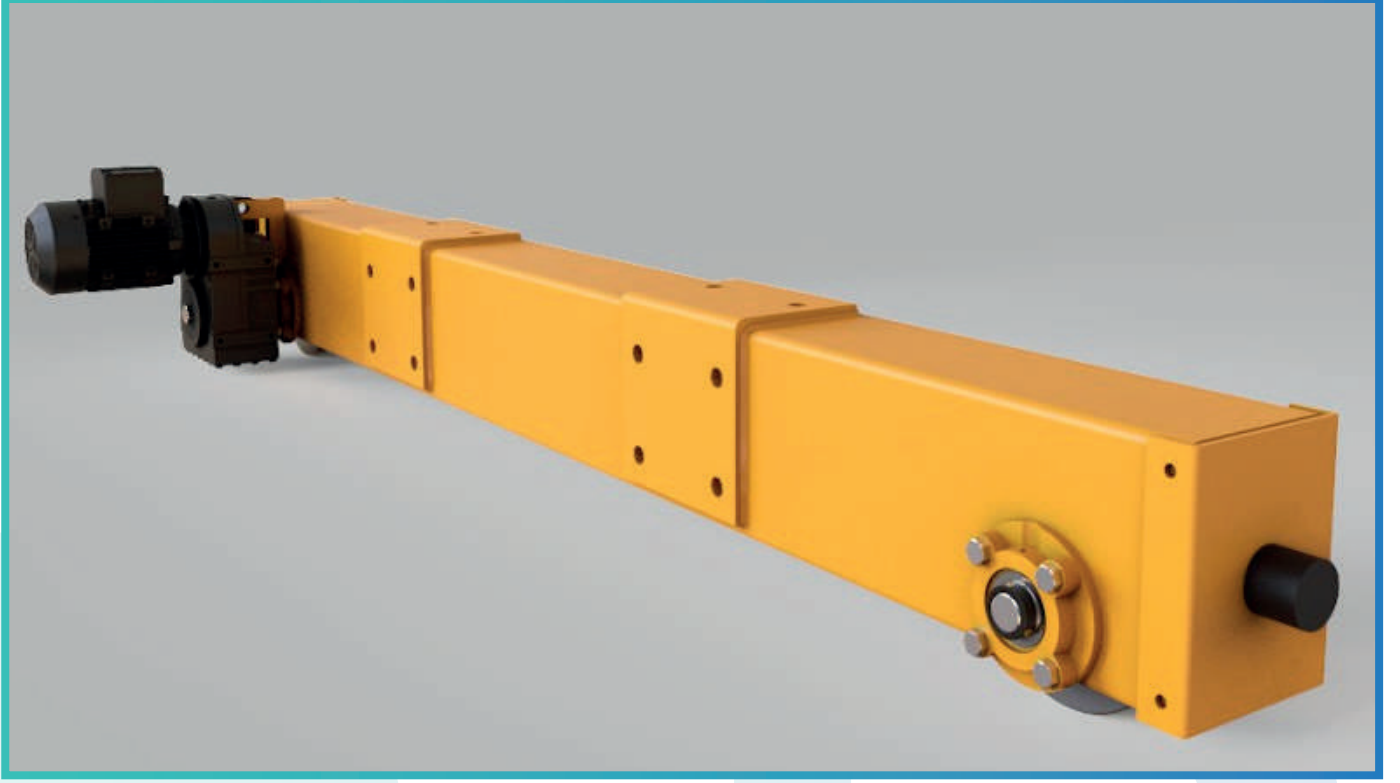

ELEKTRİK BESLEME SİSTEMLERİ

ELECTRIC SUPPLY SYSTEMS

C Profil ve I Profile Elektrik Besleme Sistemi

C Profile and I Profile Electrical Supply System

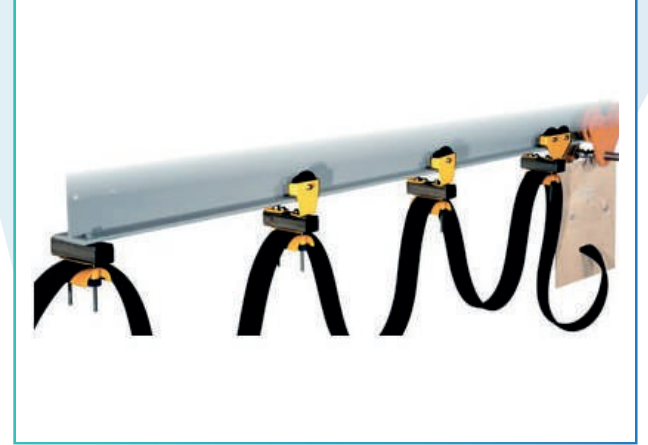
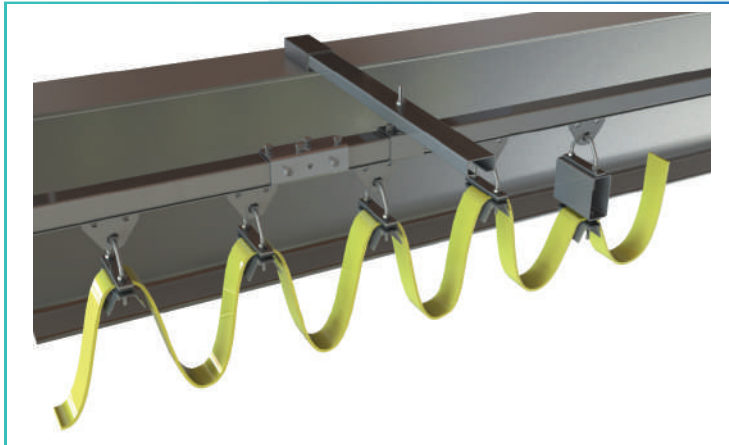
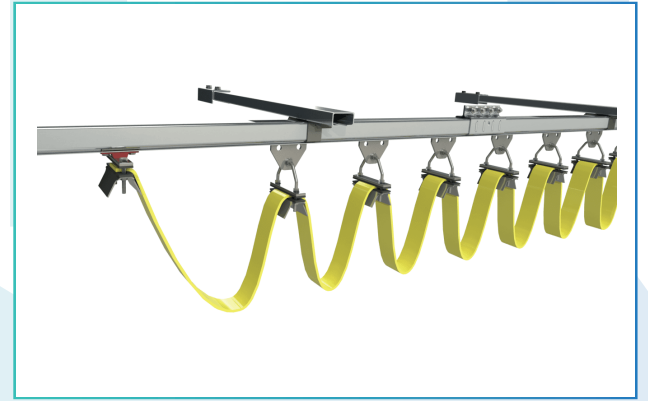
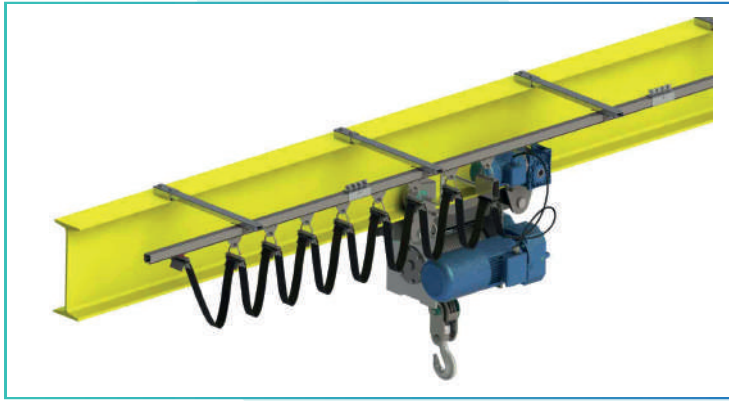
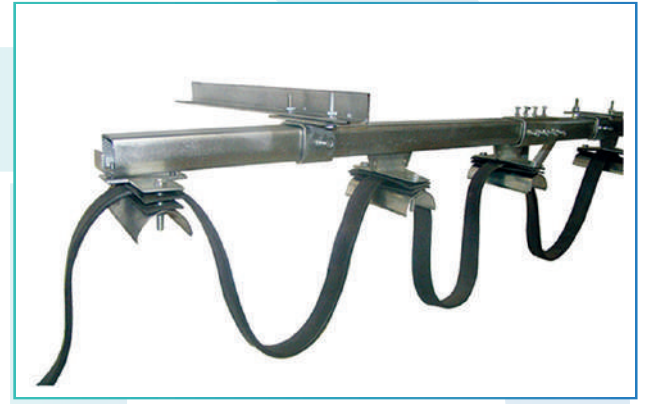
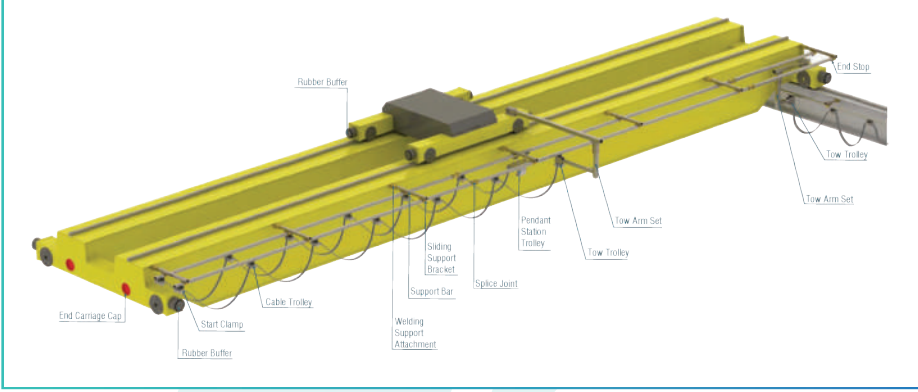

ELEKTRİK BESLEME SİSTEMLERİ

ELECTRIC SUPPLY SYSTEMS

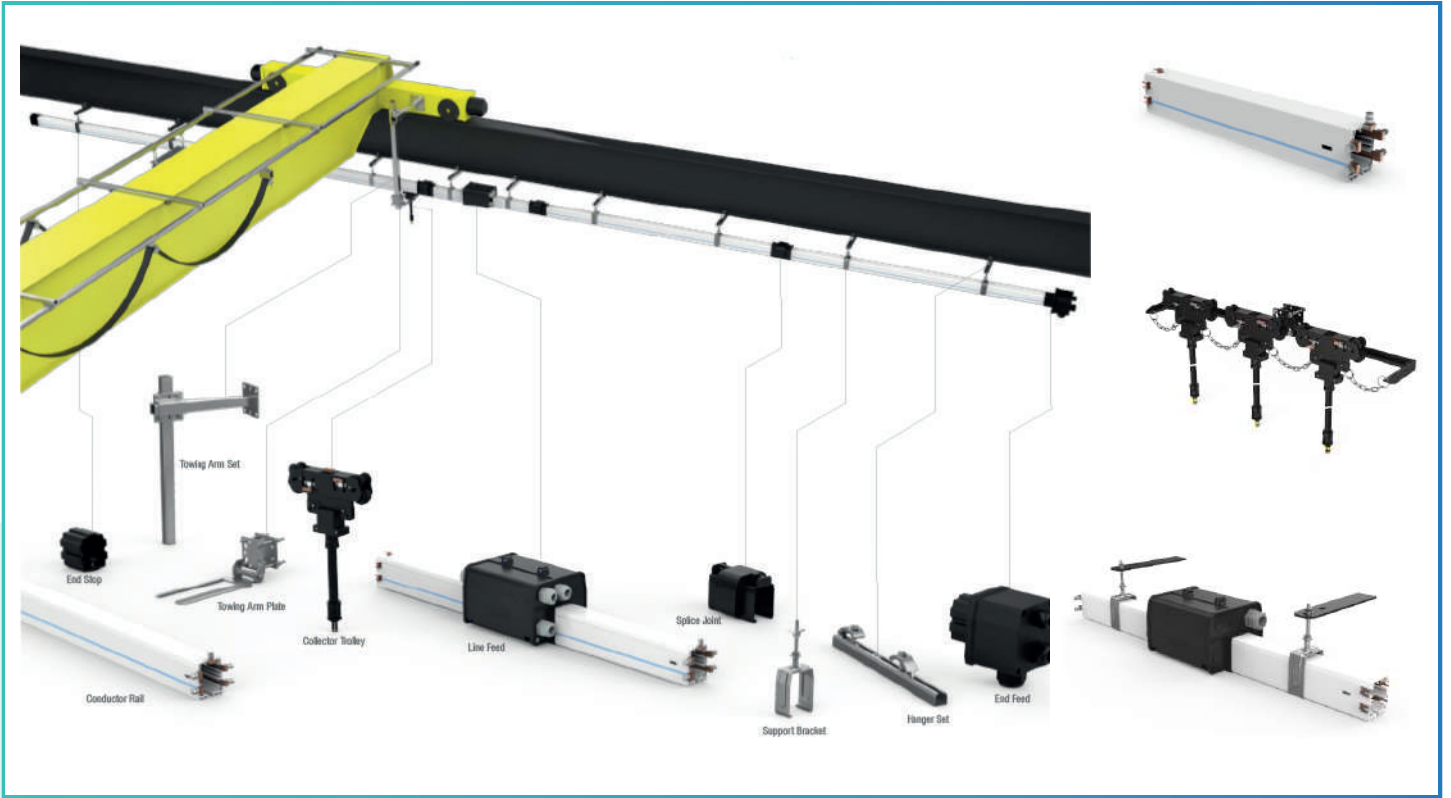

Kapalı Bara Elektrik Besleme Sistemleri
Closed Busbar Electrical Supply Systems



Açık Bara Elektrik Besleme Sistemleri
Lama Busbar Electrical Supply Systems

YEDEK PARÇA VE AKSESUARLAR

SPARE PARTS AND ACCESSORIES



Vinç Uzaktan Kumandaları / Crane Remote Controls



Kablolu Vinç Kumandaları
Wired Crane Controller

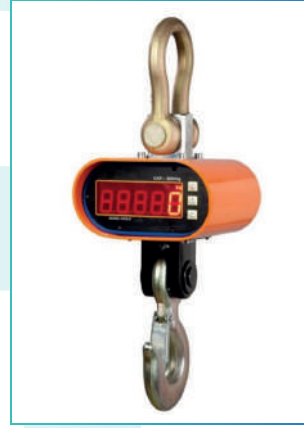

Vinç Kantarı
Crane Scale



Aşırı Yük Switchi
Overload Switcher



Halat Sarım Tamburu
Rope Winding Drum



Elektromanyetik Fren
Electromagnetic Brake



Fren Balatası
The brake lining



Halat Sarım Klavuzu
Rope Winding Guide



Hız Kontrol Cihazı
Speed Controller

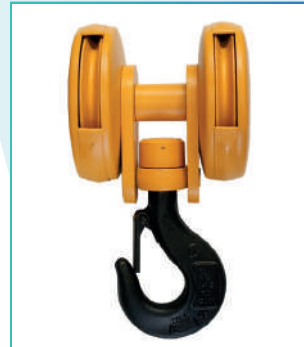

Vinç Kancası
Crane Hook



Vinç Tekeri
Crane Wheels

ÇELİK KONSTRÜKSİYON PROJELER

STELL CONSTRUCTION PROJECTS



ÇELİK KONSTRÜKSİYON PROJELER

STELL CONSTRUCTION PROJECTS



ÇİFT KİRİŞ ARABALI VİNÇ KEDİSİ DOUBLE GIRDER HOIST TROLLEY

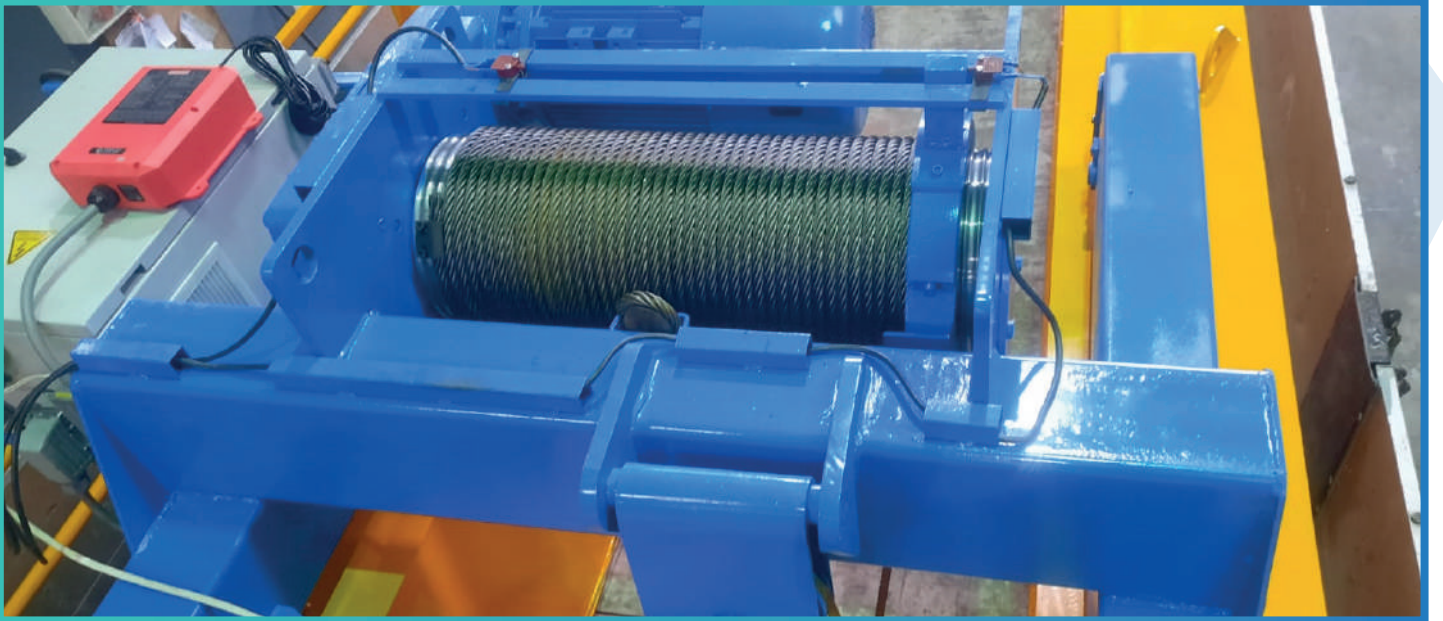
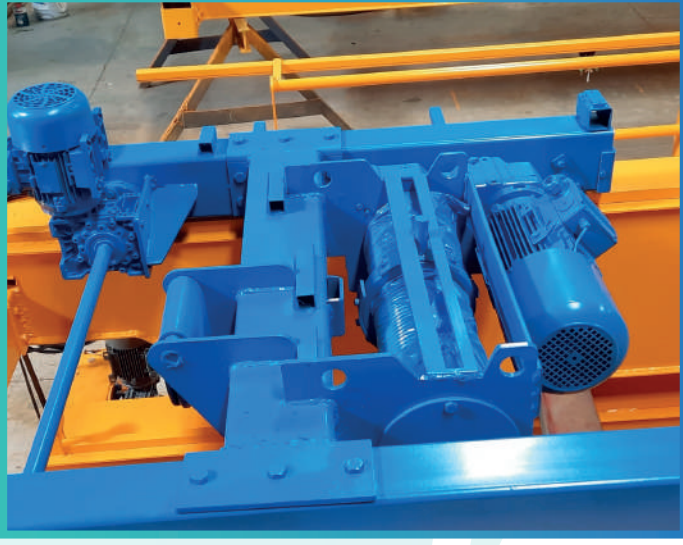

REFERANS RESİMLER

REFERENCE PICTURES



REFERANS RESİMLER

REFERENCE PICTURES

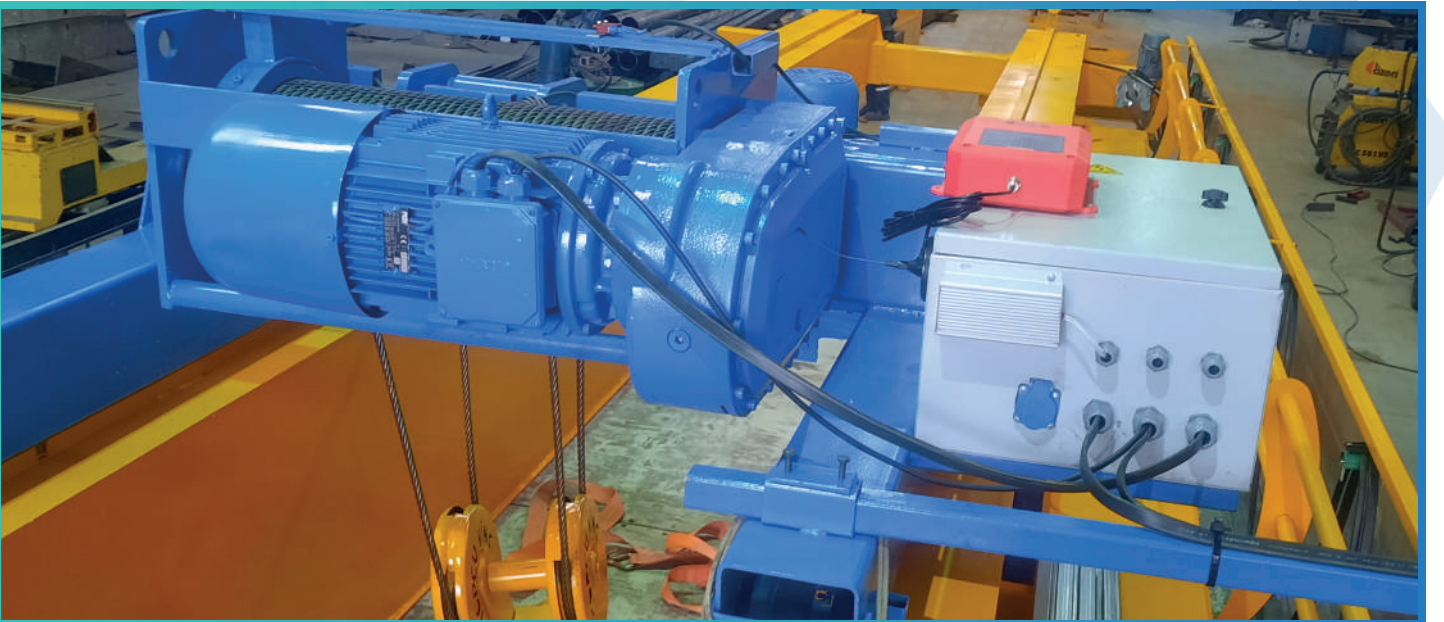
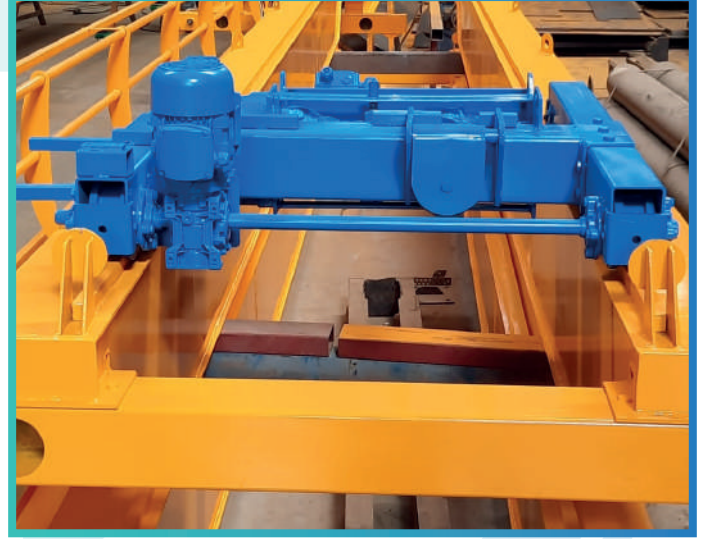



Profesyonel Teknik Servis Hizmeti

- ✓ 7 gün / 24 saat uzman ekiple acil müdahale.
- ✓ Türkiye geneli teknik servis hizmeti.
- ✓ Sürekli ürün performans takibi.
- ✓ Olası arızaların önceden belirlenerek, herhangi bir zarar oluşturmadan tamir edilmesi.
- ✓ Stoktan teslim yedek parçalar ile hızlı bakım ve servis olanağı.
- ✓ Eski Vinçlerin revizyon ve modernizasyonu.
- ✓ İSG eksikliklerine karşı periyodik bakım ve onarım hizmeti.

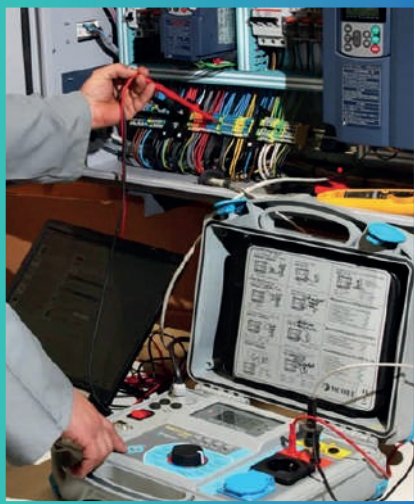

ÇÖZÜM ORTAKLARIMIZ OUR SOLUTION PARTNERS

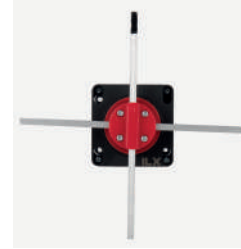
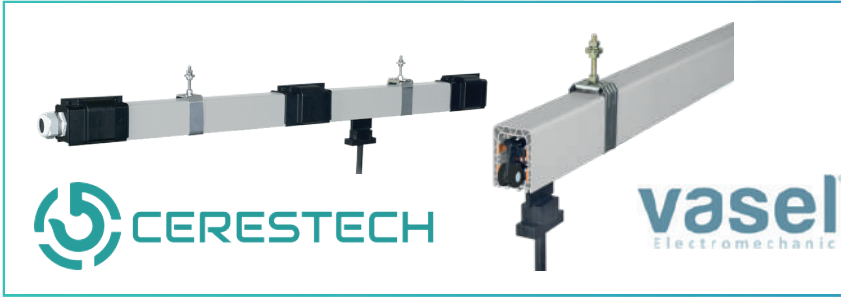

Dewilux®

MW magmaweld



Güneş Makina
Sanayi ve Tic. Ltd. Şti.



Yüksek Teknolojili Vinç Sistemleri

High Tech Crane Systems



+ 90 324 234 98 13



info@topcuvinc.com



Yalınayak Mahallesi 102099 Sk. No:33/A
TOROSLAR / MERSİN / TÜRKİYE

